

M12 male 0°/M12 female 0° shielded B-cod.Profibus

PVC 1x2xAWG24 shielded vt UL/CSA 30m

PROFIBUS

Male straight – female straight

M12, 4-pole – M12, 2-pole

B-coded

shielded

Plastic housings with good resistance against chemicals and oils.

The resistance to aggressive media should be individually tested for your application. Further details on request.

Further cable lengths on request.

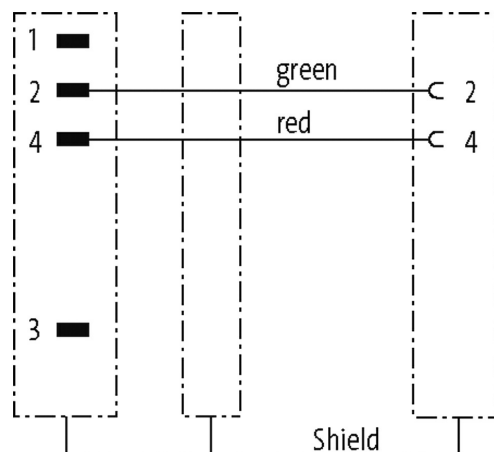
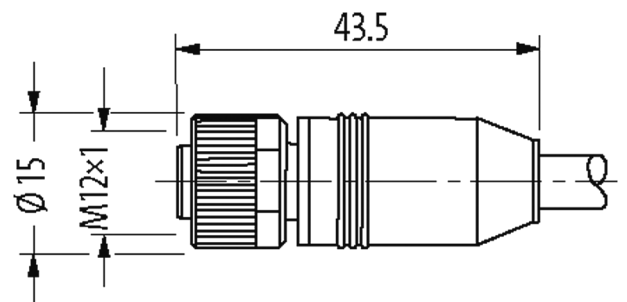
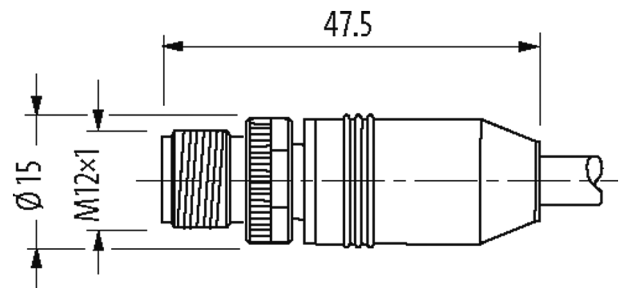
Illustration

Product may differ from Image

Approvals

cCSAus



* only for products with UL/CSA approved cable

More Info



Form

Form 44001

Cables

No./diameter of wires	1 × 2 × 0.25 mm ²
Wire isolation	PE (rd, gn)
C-track properties	2 Mio.
Material (jacket)	PVC (UL)
Outer Ø	7.8 mm ±5%
Bend radius (moving)	12 × outer Ø
Temperature range (fixed)	-25...+70 °C
Temperature range (mobile)	-20...+50 °C
Cable identification	850
Cable weight [g/m]	75,90
Material (wire)	Cu wire, bare
Resistor (core)	max. 68 Ω/km (20 °C)
Single wire Ø (core)	0.13 mm
Construction (core)	19 × 0.13 mm
Diameter (core)	1 × 2 × 0.25 mm ²
AWG	similar to AWG 24
Material (wire isolation)	PE
Wire-Ø incl. isolation	2.55 mm ±5%
Color/numbering of wires	rd, gn
Shield	yes
	min. 70%
Material (jacket)	PVC
Outer-Ø (jacket)	7.8 mm ±5%
Color (jacket)	violet
Nominal voltage	30 V AC
Test voltage	1.5 kV
Temperature range (fixed)	-25...+70 °C
Temperature range (mobile)	-20...+50 °C
Bend radius (fixed)	7.5 × outer Ø
Bend radius (moving)	12 × outer Ø
No. of bending cycles (C-track)	max. 2 Mio. (25 °C)
Traversing distance (C-track)	max. 5 m (horizontal)
Travel speed (C-track)	max. 3 m/s
Acceleration (C-track)	max. 5 m/s ²
Jacket Color	violet

Technical Data

Operating voltage	max. 60 V AC/DC
Operating voltage (only UL listed)	max. 30 V AC/DC
Rated surge voltage	1.5 kV
Operating current per contact	max. 4 A
Material group	IEC 60664-1, category I
Coding	B-coded
Locking of ports	Screw thread (M12×1 mm) recommended torque 0.6 Nm, self-securing
Compression gland	M12 (SW13)
Protection	IP65, IP66K, IP67 inserted and tightened (EN 60529)
Locking material	Zinc die casting, matte nickel plated
Material	PUR
suitable for corrugated tube (internal Ø)	without

General data

Standards	DIN EN 61076-2-101 (M12)
Mounting method	inserted, tightened
Pollution Degree	3
Temperature range	-25...+85 °C, depending on cable quality

Commercial data

country of origin	DE
customs tariff number	85444290
EAN	4048879681216
eClass	27061801
Packaging unit	1